

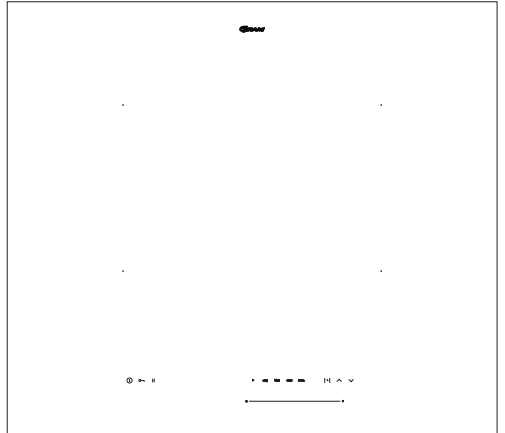

KKI 6344-90 TI



INSTRUCTION MANUAL

INDUCTION HOB

Your hob combines exceptional ease of use with excellent effectiveness. Once you have read the instructions, operating your hob will not be a problem.

Before being packed and leaving the factory, the safety and functions of this hob were carefully tested.

We ask you to read the User Manual carefully before switching on the appliance. Following the directions in this manual will protect you from any misuse.

Keep this User Manual and store it near at hand.

The instructions should be followed carefully to avoid any unfortunate accidents.

Important!

The appliance may only be operated when you have read and understood this manual thoroughly.

The appliance is designed solely for cooking. Any other use (eg heating a room) is incompatible with the appliance's intended purpose and can pose a risk to the user.

The manufacturer reserves the right to introduce changes which do not affect the operation of the appliance.

Certificate of compliance CE

The Manufacturer hereby declares that this product complies with the general requirements pursuant to the following European Directives:

- The Low Voltage Directive **2014/35/EC**,
- Electromagnetic Compatibility Directive **2014/30/EC**,
- ErP Directive **2009/125/EC**,

and therefore the product has been marked with the **CE** symbol and the **Declaration of Conformity** has been issued to the manufacturer and is available to the competent authorities regulating the market.

TABLE OF CONTENTS

SAFETY INSTRUCTIONS	4
DESCRIPTION OF THE APPLIANCE	8
INSTALLATION	9
OPERATION	13
CLEANING AND ROUTINE MAINTENANCE	24
PRACTICAL EVERYDAY TIPS	25
EMERGENCY PROCEDURE	26
TECHNICAL DATA	28

SAFETY INSTRUCTIONS

Warning: The appliance and its accessible parts become hot during use. Care should be taken to avoid touching heating elements. Children less than 8 years of age shall be kept away unless continuously supervised.

This appliance can be used by children aged from 8 years and above and persons with reduced physical, sensory or mental capabilities or lack of experience and knowledge if they have been given supervision or instruction concerning use of the appliance in a safe way and understand the hazards involved. Children shall not play with the appliance. Cleaning and user maintenance shall not be made by children without supervision.

Warning: Unattended cooking on a hob with fat or oil can be dangerous and may result in fire.

NEVER try to extinguish a fire with water, but switch off the appliance and then cover flame e.g. with a lid or a fire blanket.

Warning: Danger of fire: do not store items on the cooking surfaces.

SAFETY INSTRUCTIONS

Warning: If the surface is cracked, switch off the appliance to avoid the possibility of electric shock.

The appliance is not intended to be operated by means of an external timer or separate remote-control system.

You should not use steam cleaning devices to clean the appliance.

- Before using the ceramic plate for the first time read the Operating Manual carefully as thus you can ensure safe operation and avoid damage to the plate.
- If the ceramic plate is operated near a radio, TV set or other emitting device, please check whether the touch panel works correctly.
- The ceramic plate should be installed by a qualified electrician.
- Do not install the plate near refrigerating devices.
- The furniture the plate is fitted in should be resistant to temperatures up to 100°C. The requirement applies to the veneers, edges, plastic surfaces, glues and varnishes.
- The plate can be used only after it has been fitted into furniture, as only thus you will be protected from accidental contact with live components.
- Electric appliances can be repaired only by qualified specialists. Unprofessional repairs may compromise the safety of the appliance.
- The appliance is disconnected from the mains only when the mains plug is pulled out from the socket or when the fuse has been switched off.
- Never allow children to remain unattended near the cooktop nor to play with the control panel.
- When switched on the hotplates quickly become hot. To avoid unnecessary power consumption, switch them on only after putting a cooking pot.
- Residual temperature indicator built-in into the electronic system tells you whether the hotplate is still switched on and whether it is still hot.
- Should there be a power failure, all the settings and indications will be cancelled. Please be careful when the power supply is restored as hotplates which have been hot before power failure will no longer be controlled by the indicator.
- If there is a mains socket located near the hotplate, please make sure that the supply cord does not touch the hot places.
- Do not leave the plate unattended when cooking on fats and oils as they create fire hazard.

SAFETY INSTRUCTIONS

- Do not use plastic pots or containers made from aluminium foil as they melt in high temperatures and may damage the ceramic plate.
- Sugar, citric acid, salt etc., both in liquid and solid state, as well as plastic should not get into contact with a hot hotplate.
- If through carelessness, sugar or plastic gets on a hot hotplate, you may not switch off the plate but scrape away sugar or plastic using a sharp scraper. Protect hands from burns.
- Use only flat-bottom pots and saucepans on your ceramic plate, without sharp edges or burrs as otherwise the plate may get permanently damaged.
- The heating surface of the ceramic plate is resistant to thermal shock. It is neither hot nor cold-sensitive.
- Avoid dropping objects on the plate. A point hit, for example a falling bottle with spices, may in unfavourable circumstances lead to cracks and splits appearing on your ceramic plate.
- Boiled over residuals of food may penetrate damaged places and get to the live components of the ceramic plate
- Should cracks or splits appear on the surface of your ceramic plate immediately disconnect it from the mains. In order to do so, switch off the fuse or pull out the mains plug from the socket. Call the Customer GRAM Service
- Please observe the maintenance and cleaning guidelines. Should you fail to proceed in compliance with the provided guidelines, you will lose your warranty rights

ENERGISPARETIPS



Hvis du sparer på energien, er det godt for miljøet, og det vil reducere din elregning.

Du kan gøre det på følgende måde:

- **Brug rigtigt kogegrej til tilberedning af mad.**

Ved brug af gryder med flad og tyk bund kan du spare op til 1/3 energi. Husk at lægge grydens låg på, ellers stiger elforbruget.

- **Hold kogezonerne og gryderne rene.**

Snavs forhindrer varmeoverførsel – snavs, som er brændt fast, kan ofte kun fjernes ved hjælp af stærkt miljøbelastende midler.

- **Undgå at kigge i gryder, når det ikke er nødvendigt.**

- **Undgå at indbygge kogepladen i nærheden af køleskabe/frysere.**

Det medfører unødigt stigning i elforbruget.

UDPAKNING



Apparatet er blevet sikret mod transportskader under befordringen ved hjælp af en emballage. Efter foretaget udpakning bedes du sørge for, at emballagens

elementer bortskaffes på en miljøvenlig måde.

Alle materialer anvendt til emballeringen er miljøvenlige og 100% genanvendelige. De er markeret med et relevant symbol.

Bemærk!

Emballagemateriale (polyetylenposer, stykker af polystyrenskum) skal under udpakningen holdes væk fra børn.

BORTSKAFFELSE AF ELEKTRONIKSKROT



Når dette produkt er udtjent, må det ikke bortskaffes via normalt husholdningsaffald, men skal afleveres til en indsamlingsplads for genbrug af elektriske og elektroniske produkter. Symbolet på produktet,

betjeningsvejledningen eller emballagen henviser til det.

Materialerne er genanvendelige ifølge deres mærkning. Ved genbrug, genanvendelse af stoffer eller andre former for genanvendelse af udtjente produkter bidrager du væsentligt til at beskytte miljøet.

Oplysninger om rette bortskaffelsespladser for udtjente elektroniske og elektriske produkter kan fås ved henvendelse til kommunen.

DESCRIPTION OF THE APPLIANCE

Description of hob

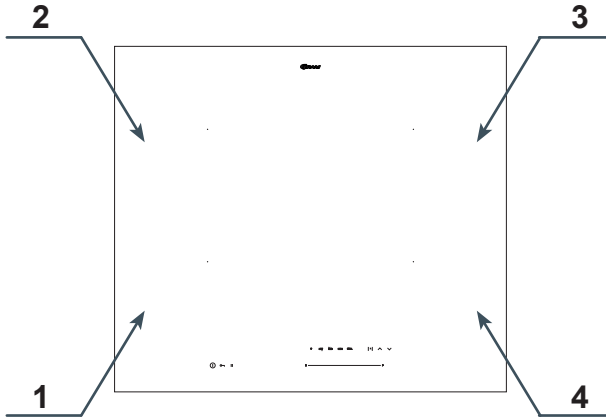

- | | |
|--|---|
| 1. Power Booster induction cooking zone Ø 210 (front left) | 3. Power Booster induction cooking zone Ø 210 (rear right) |
| 2. Power Booster induction cooking zone Ø 160 (rear left) | 4. Power Booster induction cooking zone Ø 160 (front right) |

Control Panel

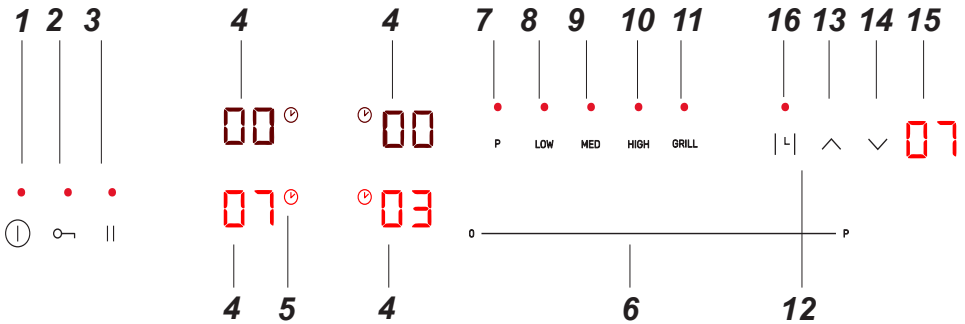

- | | |
|---|------------------------------------|
| 1. On/off touch sensor | 9. 70°C programme |
| 2. Child Lock touch sensor | 10. 90°C programme |
| 3. Stop & Go sensor | 11. Grill programme |
| 4. Cooking zone select touch sensor and power indicator | 12. Timer touch sensor |
| 5. Timer active indicator | 13. Add time touch sensor |
| 6. Power selection - SliderControl | 14. Reduce time touch sensor |
| 7. Booster touch sensor | 15. Remaining time indicator |
| 8. 40°C programme | 16. Minute Minder active indicator |

INSTALLATION

Making the worktop recess

- Worktop thickness should be 28 - 40 mm, while its width at least 600 mm. The worktop must be flat and level. Edge of the worktop near the wall must be sealed to prevent ingress of water or other liquids.
- There should be sufficient spacing around the opening, in particular, at least 50 mm distance to the wall and 60 mm distance to the front edge of worktop.
- The distance between the edge of the opening and the side wall of the furniture should be at least 55 mm.
- Worktop must be made of materials, including veneer and adhesives, resistant to a temperature of 100°C. Otherwise, veneer could come off or surface of the worktop become deformed.
- Edge of the opening should be sealed with suitable materials to prevent ingress of water.
- Worktop opening must cut to dimensions as shown on figure 1.

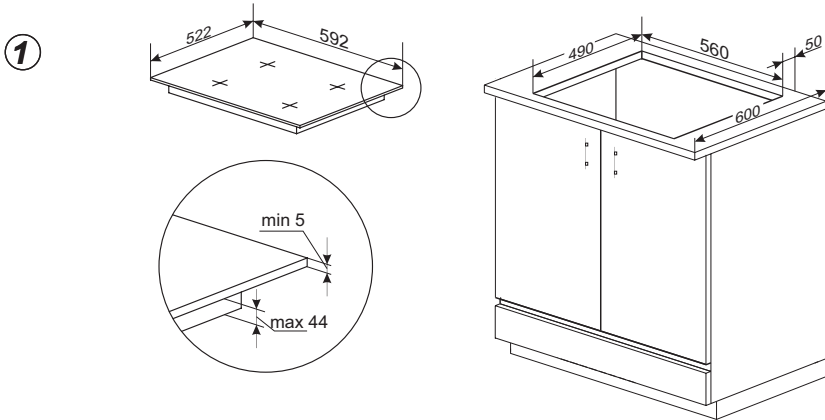

Do not install the hob above the oven without ventilation.

INSTALLATION

Variant 1

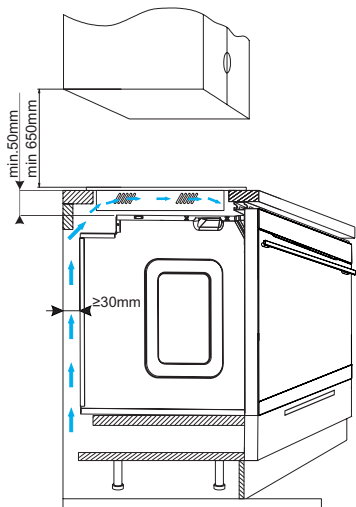

Variant 2

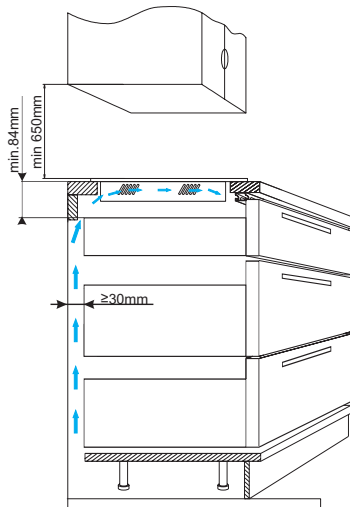

If the gap under the hob is not maintained as in variant 2, then a ventilation gap at the front is necessary.

Variant 3

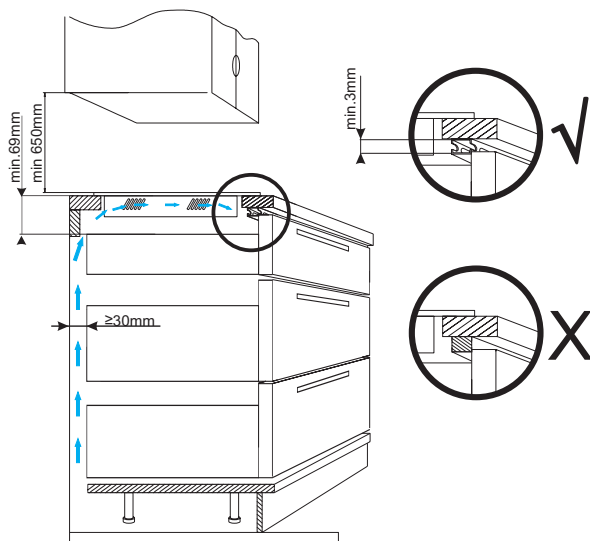

INSTALLATION

Assembly of the gasket

*Depending on the model, the seal is already installed at the factory (fig.1)

If the seal has not been fitted at the factory, proceed as follows:

Before installing the hob in the cut-out worktop, the gasket is to be attached to the back of the hob (pic. 2)

To do this, first peel off the protective film from the self-adhesive seal and glue the gasket as close as possible to the outer edge of the hob (fig. 3,4).

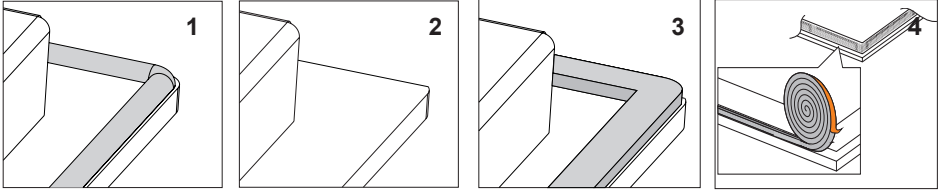

Do not install the appliance without the foam gasket.

Then turn the hob over insert it into the cut-out of the furniture. Align the positioning symmetrically so that the distances between the hob and the countertop is the same on all sides. (fig. 5)

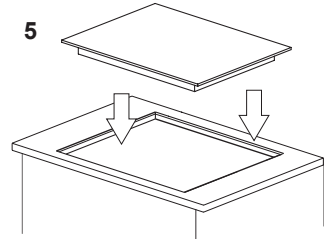

Inside the packaging you will find accessories necessary to connect the appliance to home electrical system. Use the enclosed accessories to ensure the proper operation of the appliance. The accessories include: Strain relief, bridge connection, 2 screws and connection terminal cover.

Install the strain relief using the provided screws.

Install the terminal cover by inserting it until it snaps in place with a click.

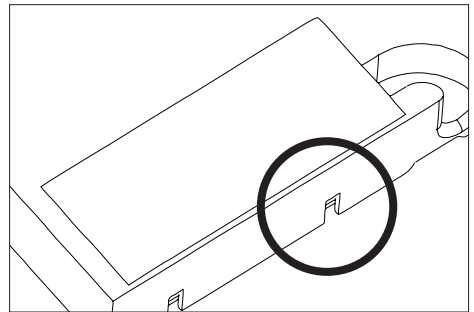
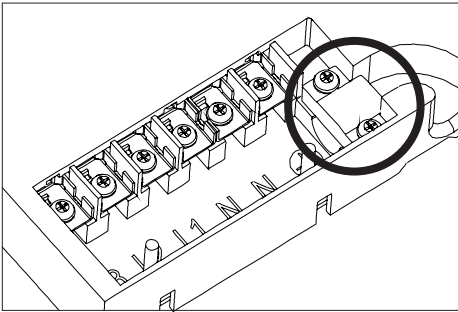

In order to remove the cover, use a screwdriver to pry the fastening tabs until the cover pops off.

INSTALLATION

Tips for the installer

The hob is equipped with a terminal block allowing different connections appropriate for a specific type of power supply.

Terminal block allows the following connections:

- single-phase 220-240 V ~
- two-phase 380-415 V 2N~

The hob can be adapted to a specific type of power supply by bridging the appropriate terminals according to wiring diagram. Wiring diagram is placed on the hob's underside. The terminal block can be accessed by removing the lid on hob's underside. Remember to match the power cord to the type of connection and the hob's power rating.

Important!

Remember to connect the neutral lead to correct terminal block clamp, marked with \oplus . The electrical system supplying the hob must be protected by a properly selected tripping device or a circuit breaker allowing to disconnect the power supply in an emergency.

Before connecting the appliance to power, please carefully read the information provided on the rating plate and wiring diagram.

Connecting the hob other than shown on the wiring diagram may damage the hob.

CAUTION! The installer is obliged to provide the user with "appliance electrical connection certificate" (enclosed with the warranty card). After installation, the installer should also provide information on the connection made:- single-phase, two-phase,- conductor cross-section,- electrical protection (fuse type).

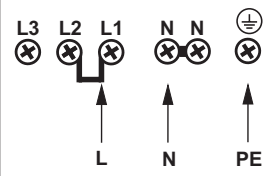
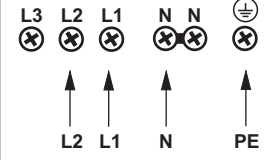
WIRING DIAGRAM				
Danger! High Voltage!				
Note! For each connection the protective earth (PE) conductor must be connected to the terminal marked \oplus .			Type/ conductor cross section	Fuse protection
1	The 220-240 V AC 50/60 Hz single phase connection. Bridge the L1 and L2 terminals. Connect the phase conductor to the L1 terminal and tighten the bolt. Connect the neutral conductor to the N terminal. Connect the protective earth PE conductor to the PE terminal (\oplus).	1N~ 	HO5VV-F3G4 3x4 mm ²	32 A
2*	The 220-240/380-415V AC 50/60 Hz two phase connection. Connect the phase L1 conductor to the L1 terminal and the phase L2 conductor to the L2 terminal and tighten the bolts. Connect the neutral conductor to the N terminal. Connect the protective earth PE conductor to the PE terminal (\oplus).	2N~ 	HO5VV-F4G2,5 4x2.5 mm ²	16 A

L1=R, L2=S, L3=T; N = neutral conductor terminal; \oplus = protective earth (PE) conductor terminal

OPERATION

Operate your induction hob

Under the surface glass, there are induction coils that produce pulsing magnetic field. This electromagnetic field penetrates a pot placed on the hob surface causing the pot to heat up. It is important to use pots with a suitable base.

Depending on the pots used and heat setting during cooking, the appliance produces a distinctive whiz. This is normal and does not constitute grounds for a complaint.



Cookware characteristics

- To check that the pot is suitable for your induction hob, make sure that a magnet strongly attracts its base. The greater the attraction force, the better the pot.
- Always use high-quality cookware with a perfectly flat base. The use of this kind of cookware prevents hot spots that may result in food sticking to the pot. Pots and pans with thick steel walls provide superior heat distribution. The concave base or deep embossed logo of the manufacturer interfere with the temperature induction control module and can cause overheating of the pot or pan.
- Do not use damaged cookware such as cookware with deformed base due to excessive heat.

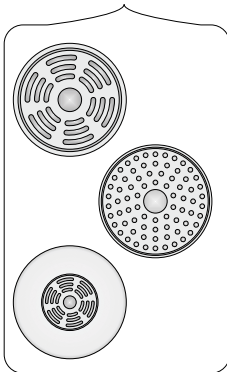

- When you use large ferromagnetic base cookware (where the magnet is attracted), whose diameter is less than the total diameter of the cookware, only the ferromagnetic base heats up. This results in a situation where it is not possible to uniformly distribute the heat in the cookware. If the ferromagnetic area is reduced due to inclusion of aluminium parts then the effective heated area can be reduced. Problems with the detection of the cookware could arise or cookware may not be detected at all. To achieve optimum cooking results, the diameter of the ferromagnetic base should match that of the cooking zone. If cookware is not detected in a given cooking zone, it is advisable to try it in a smaller cooking zone.

OPERATION

Pan detector

Induction hobs feature a pan detector. The hob will detect the presence of a suitable pan placed on a cooking zone and automatically activate it. This helps save electricity.

- If a suitable cookware is placed on the cooking zone, the set power level is shown on the corresponding display.
- The induction hob requires the use of suitable cookware with ferromagnetic base (see Table on page 16).

If cookware is not placed on a cooking zone or the cookware is unsuitable, the symbol shown beside is displayed.

The cooking zone does not operate.

If cookware is not detected within 90 seconds, the cooking zone will be switched off.

Use the control panel to turn off a cooking zone and do not rely just on removing the cookware from the hob.



 The high-quality cookware is essential for efficient induction cooking. Using empty cookware on the cooking zones may cause them to overheat.

 It is not recommended to use external induction adapters.

 For induction cooking use only ferromagnetic base materials such as:

- enamelled steel
 - cast iron
 - special stainless steel cookware designed for induction cooking.
- Lid prevents heat from escaping and thus reduces heating time and lowers energy consumption.
 - Make sure that cookware base is dry. When filling cookware or when using cookware taken out of the refrigerator make sure its base is completely dry before placing it on the cooking zone. This is to avoid soiling the surface of the hob.

OPERATION



Kitchen cookware marking



Check for marking indicating that the cookware is suitable for induction cooking.

Stainless Steel

Cookware is not detected
With the exception of the ferromagnetic steel cookware

Aluminum

Cookware is not detected

Cast iron

High efficiency
Note: cookware can scratch the hob surface

Enamelled steel

High efficiency
Cookware with a flat, thick and smooth base is recommended

Glass

Cookware is not detected

Porcelain

Cookware is not detected

Cookware with copper base Cookware is not detected

The smallest useful diameter of cookware for a cooking zone:

Cooking zone diameter	The minimum diameter of the bottom of an enamelled steel cookware
[mm]	[mm]
160 - 180	110
180 - 200	
220 x 190	
210 - 220	125
260 - 280	

The minimum diameter of cookware made of materials other than enamelled steel may vary.

OPERATION



Before using the appliance for the first time



- Thoroughly clean the induction hob. The hob has a glass surface, therefore handle it with care.
- Odours may be released when you first start your appliance. If this happens, turn on exhaust hood or open the window in the room. Emission of odour is temporary.



Power management

This function allows you to activate the demonstration mode and to limit the total maximum power of your induction hob to one of the following values: 2.8kW; 3.7kW; 4.5kW; 5.6kW; 7.35kW (maximum power).



You need to specify the total maximum power of your induction hob within 5 minutes of connecting the induction hob to the mains. To select a power setting, touch  to turn on the appliance and then touch and hold  and  simultaneously for 3 seconds.

The twin display will show the previous setting or — if there was no previous setting — the default setting of 7.35kW shown as “74”. Use  and  to select the desired setting:

Within 10 seconds of selecting the desired setting, touch and hold   for 3 seconds to confirm.

00	DEMO
28	2.8kW
37	3.7kW
45	4.5kW
56	5.6kW
74	7.35kW



You will hear a beep and the selected maximum power setting will flash several times on the display and then the appliance will turn off. Now your operating induction hob will not exceed the total maximum power you selected.



If you do not confirm the selected maximum power setting, your induction hob will turn off and operate with the previously selected maximum power or with the default power of 7.35kW.

When you select heat setting on individual cooking zones, the Power Management circuit will ensure that the selected total maximum power is not exceeded. Any setting that would cause the total maximum power to be exceeded will be unavailable to the user.

The Power Management circuit may disable a cooking zone if using it would cause the total maximum power of the appliance to be exceeded.

OPERATION

Control Panel

- Immediately after the appliance is connected to electrical mains, all displays will light up briefly. Your appliance is then ready for use.
- The induction hob is equipped with electronic touch control sensors, which are operated by touching with a finger for at least 1 second.
- Touching of a sensor is accompanied by a beep to acknowledge.



Do not place any objects on the sensors of the control panel. Make sure that cookware is not placed beyond the outline of the cooking zone. If you place cookware too close to the control panel or you cover any sensors, the hob will automatically turn off for safety.

Turn on the appliance

- ⓘ ⇨ || Touch and hold the on/off ⓘ sensor for at least 3 seconds. The Hob indicates correct operation (active) when “00” is shown on the cooking zone displays.



If you do not set the desired heat setting of the cooking zone within 15 seconds of activating the appliance, it will turn off automatically.

Activate cooking zone and set the heat setting.

- Turn on the hob with the ⓘ sensor.
- Place the cookware on the desired cooking zone.
- The cookware will be automatically detected and the relevant display **8.8** will show flashing “00.” This means that the selected cooking zone is active and you can set the power.



If there are two or more pans on the hob when it is turned on, the hob will not activate the cooking zones automatically. You need to touch the sensor **8.8** corresponding to your desired cooking zone.

- To select the desired heat setting slide your finger across the heat setting sensor starting from the left (the display will show the selected heat setting).
- The cooking zone operates.



The cookware detection and automatic cooking zone activation only works for the first pan placed on the hob.

OPERATION

Deactivate cooking zones

Deactivate cooking zone by doing one of the following:

- Turn off the hob with the  sensor.
- Touch and hold the **8.8** sensor for 3 seconds
- Touch the heat setting slider sensor and slide your finger to the left to reduce the heat setting to "00."

Turn off the appliance



The appliance operates when at least one cooking zone is on.

- Turn off the hob with the  sensor.



If a cooking zone is still hot, the relevant display will show the letter "H" or "h" to indicate residual heat. For description of the symbol, see below.

Booster function "P"

The Booster Function increases the nominal power of the Ø 210 mm cooking zone from 2000W to 3000W, Ø 160 mm cooking zone from 1400W to 2100W.

- Place the cookware on the desired cooking zone.
- The cookware will be automatically detected and the relevant display **8.8** will show flashing "00."
- Touch the Booster sensor or slide your finger on the heat setting sensor to the right to activate the Booster function. The display will show the letter "P."

Turn off the Booster function:

- Touch the Booster sensor or slide your finger on the heat setting sensor to the left to deactivate the Booster function.



Booster function can be activated for up to 5 minutes. Then power will be reduced to 14 (nominal power).

Power will also be reduced to the nominal power, if any hob components overheat.

You can reactivate the Booster function when the internal components cool down to a safe temperature. This function will not start automatically.



When you take the cookware off the cooking zone when the Booster function is on, a 5-minute countdown will not be interrupted.

OPERATION



The Booster function can be activated for two cooking zones at the same time, i.e. one of the left cooking zones and one of the right cooking zones. You will not be able to activate the Booster function if another cooking zone on the same side already has the Booster function activated.

Child Lock

The Child Lock function disables all hob controls for cleaning or to prevent children from using the appliance. The Child Lock function can be set when the appliance is turned on or off. To enable or disable the Child Lock function, hold the  sensor for 3 seconds. When the lock is on, an indicator light next to the  sensor is on.



When the hob is turned on and locked, you can turn it off immediately by touching the  sensor.



Disconnecting the appliance from electrical mains deactivates the Child Lock.

Residual heat indicator "h", "H"

When you have finished cooking, the induction hob glass within the cooking zone is still hot, this is called residual heat.

If the glass temperature is higher than 60°C*, display of the cooking zone shows "H".



If the glass temperature is 45°C* – 60°C*, the cooking zone display shows "h" (low residual heat).



* Temperatures are approximate



When residual heat indicator is on, do not touch the cooking zone as there is a risk of burns and do not place on it any items sensitive to heat!



The "H" or "h" residual heat indicator is not displayed during a power outage. However, cooking zones may still be hot!

OPERATION

Limit the operating time

In order to ensure the safety of users, the induction hob is fitted with an operating time limiter for each of the cooking zones.

The maximum operating time is determined individually depending on the heat setting when cooking. If you only use one heat setting for an extended period of time, the maximum cooking time is given in the table:

After reaching the maximum cooking time, the induction zone deactivates automatically, and the display shows residual heat symbol. The maximum working time applies to a single cooking zone.



Cooking heat setting	Maximum operating time
1	8h
2	8h
3	8h
4	8h
5	5h
6	5h
7	5h
8	5h
9	1.5h
10	1.5h
11	1.5h
12	1.5h
13	1.5h
14	1.5h
P	5min
40	60min
70	160min
90	160min
Grill	60min

Timer

Timer function makes cooking easier by making it possible to set Duration.

You can activate the Timer function only when cooking (when heat setting is greater than "0"). You can use the Timer function on all cooking zones at the same time. Maximum time is 99 minutes (1 minute step).



To set the timer:

- Place the cookware on the desired cooking zone.
- When cookware is auto detected, set the heat setting.
- To activate the Timer touch and hold  until you hear a beep. The display will show "00."
- Touch  to add time and  to reduce time.

To set the Timer for the next cooking zone, follow the above steps by selecting a different cooking zone. Keep in mind that the Timer function can be set for each cooking zone.



If more than one timer is set the shortest duration is displayed.

Timer Duration setting can be changed at any time. During cooking, select the cooking zone for which you wish to change timer duration setting, i.e. activate it with the  sensor, touch  and change the duration setting as per Timer setting instructions.

OPERATION

When the set cooking time has elapsed, you will hear an alarm beep. Touch any sensor to mute it or the alarm will turn off automatically after 30 seconds.

If you want to cancel the timer ahead of time, activate the desired cooking zone by touching its sensor (the power indicator will flash), then cancel the timer as follows:

- touch and hold the |⁺| sensor;
- touch ▼ to reduce the time to "00";
- simultaneously touch and hold ^ and ▼.

To cancel the Timer touch **8.8.** (heat setting indicator will flash), then touch and hold |⁺| for 3 seconds or touch **8.8.** to activate the desired cooking zone, then touch |⁺| and use ▼ to reduce the time to "00."

To cancel the Timer you can also simultaneously touch and hold ^ and ▼ for 2 seconds.

Minute Minder

Use Minute Minder to count down time. The Minute Minder does not affect the operation of cooking zones.

To set the Minute Minder:

- Turn on the hob.
- Touch |⁺| and set the Minute Minder duration by touching ▼ to add duration and ^ to reduce duration.



The Duration setting can be changed at any time. To do this, touch |⁺| and then use ^ or ▼.

When the set Duration has elapsed, you will hear an alarm beep. Touch any sensor to acknowledge and mute it. The alarm goes off automatically after 30 seconds.



To cancel the Minute Minder touch |⁺|, then touch and hold ▼ to reduce the duration to "00." or, alternatively, simultaneously touch and hold ^ and ▼.

The Stop'n go function

The Stop'n go function simultaneously suspends operation of all cooking zones and then resumes at the heat settings that were previously set.

In order to activate the Stop'n go function, at least one cooking zone must be in use. Touch the || sensor. All cooking zone displays will show the || symbol. When a cooking zone is hot the || symbol will flash alternately with the letter "H" or "h", depending on cooking zone temperature (residual heat indicator).

To deactivate the Stop'n go function touch the || sensor again. Cooking zone displays will show the heat setting that was previously set before activation of the Stop'n go function.

The Stop'n go function pauses the Timer countdown

The Stop'n go function does not pause the Minute Minder countdown

OPERATION

Maintain temperature

Your hob is equipped with special programmes that allow you to cook at the set temperature while consuming the least possible amount of energy.

Four programmes are available:

- **Melt 40**
This is intended for melting butter or a bar of chocolate.
Place the butter or chocolate in a pan at room temperature and then activate the Melt 40 programme.
- **Simmer 70**
A programme ideal for heating thick soups or sauces.
Place the pot with the food on the cooking zone and activate the Simmer 70 programme. This programme maintains a temperature of 70°C.
- **Cook 90**
A programme intended for heating and cooking watery dishes.
Place the pot with the food on the cooking zone and activate the Simmer 90 programme. This programme maintains a temperature of 90°C.
- **Grill**
A programme intended for grilling dishes that require high temperature.
Place a pan or a dedicated grill tray on the cooking zone and activate the Grill programme. The programme maintains a temperature of 200°C.



Activate the maintain temperature programme.

- Place the cookware on the cooking zone
- Activate the cooking zone
- Activate the selected temperature program



Temperature is indicative and may vary depending on the amount, type of load and dishes.



Pair and operate a kitchen hood*

To start wireless pairing of your kitchen hood and hob touch and hold the automatic mode sensor for 3 seconds. The  indicator will flash above the sensor. The  indicator lights up permanently when the appliances are successfully connected.



In automatic mode the hood adjusts the fan speed automatically depending on the intensity of cooking. Touch  to activate the automatic hood mode.

The indicator above the sensor will light up. Please note that the automatic mode can only be enabled when the appliances are paired.

Touch  to disable the automatic mode. The indicator above the sensor will go out. Using the  and  sensors to manually control the fan speed. When you use these sensors the automatic hood mode will be disabled.



It is recommended to use temperature programmes for pots at least half filled with food.

It is recommended to use temperature programmes on a cold cooking zone.
*depending on the model

CLEANING AND ROUTINE MAINTENANCE

Daily cleaning and proper maintenance have crucial impact on the durability of your ceramic plate.



Clean the ceramic plate observing the same rules as for glass. Never use abrasive or aggressive cleaning agents, scrubbing powders or scratching sponges.

Cleaning the plate after every use

- Wipe off slight, not-burnt patches of dirt using damp cloth without cleaning agent. Washing liquid can cause blue discoloration to appear on the plate. The stubborn stains often cannot be removed after first cleaning, even if special cleaning agents are used.
- Remove larger patches of dirt, strongly sticking to the plate using sharp scraper and wipe off the surface with a damp cloth.

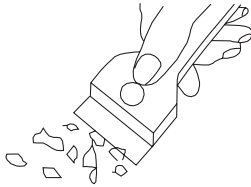

Removal of stains

- Light pearly stains (aluminium residues) can be removed from cooled plate using special cleaning agents. Calcareous residues (i.e. boiled over water) can be removed with vinegar or special cleaning agents.
- Do not switch off the hotplate when removing sugar, sugar-containing food, plastic or aluminium foil! Immediately scrape off the residuals (when still hot) from the hotplate using a sharp scraper. When the dirt is removed you can switch off the plate and clean it again after cooling down using special cleaning agents.

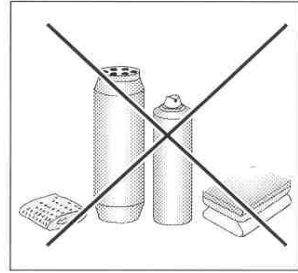

Special cleaning agents can be bought in supermarkets, special electromechanical shops, drugstores and shops with kitchen appliances. Sharp scrapers can be bought in DIY shops, shops with building tools and painting accessories.

Never apply cleaning agent on a hot hotplate. Leave the cleaning agent to dry and then wipe it off with a wet cloth. Any residuals of cleaning agents should be wiped off with a damp cloth before heating the plate for the next time, as otherwise they can have caustic effect.

Failure to observe the ceramic plate maintenance instructions can result in losing your warranty rights!

Caution!

If from any reason you are not able to control the switched on plate, switch off the main switch or screw out the fuse and call the Customer Service.

Caution!

Should cracks or splits appear on the surface of your ceramic plate, immediately disconnect the plate from the mains (by switching off the fuse or unplugging the plug) and call the Customer Service.

PRACTICAL EVERYDAY TIPS

Table of example hob settings

FUNCTION	USE	DISH	TIME [MIN]	PORTION SIZE
Melt 40*	Melt chocolate	Brownie / Chocolate Fondant	10	300 g
Melt 40*	Defrost	Pork neck / Bigos	60	1 piece approx. 800 g
Melt 40*	Proof yeast dough	Yeast dough	40	1 kg
Simmer 70*	Parboil meats and sausages	Pork loin with spices	60	1 kg
Simmer 70*	Sous vide	Sous-vide chicken fillet	60	1 piece. 200 g
Simmer 70*	Maintain temperature	Goulash soup	30	2 l
Simmer 70*	Keep warm	Breakfast cereal milk	10	0.5 l
Cook 90*	Healthy breakfast	Oatmeal	20	0.5 l
Cook 90*	Soup	Chicken broth	150	4 l
Cook 90*	Cooking	Poached eggs	12	2 pcs. egg l
Grill**	Grilling	Grilled Steak - Entrecote	6	1 piece. 300 g
Grill**	Stir-fry	Chicken with vegetables and noodles	8	1 portion about 400 g
Grill**	Deep fry	Vegetables in tempura	6	300 g

*symbol depends on the model

** in selected models

EMERGENCY PROCEDURE

In the event of any fault:

- turn off the appliance
- disconnect the power supply
- have the appliance repaired
- Based on the instructions given in the table below, some minor issues can be corrected by the user. Please check the consecutive points in the table before you refer the repair to customer GRAM service.

PROBLEM	POSSIBLE CAUSE	REMEDY
The “L” symbol is shown on the display when you try to turn on the appliance.	The Child Lock is enabled.	Touch and hold the Child Lock sensor for 3 seconds to disable the Child Lock.
The appliance does not turn on when you press the on/off sensor.	You do not hold down the on/off sensor long enough	Hold down the on/off sensor for 3 seconds.
	Soiled / wet control panel sensors	Wipe the control panel clean and remove any objects that obscure the sensors.
	Power outage	Check the MCB or fuses in your home electrical distribution box.
	External power interference.	Unplug the appliance from the power outlet for 120 seconds or disconnect the miniature circuit breaker (MCB) or fuse in your home electrical distribution box.
During operation, the appliance emits a long beep and turns off.	The safety feature has operated.	Wipe the control panel clean and remove any objects that obscure the sensors.
After turning on, the appliance turns itself off.	You have not used any appliance function.	When turn on the appliance, use it without delay.

EMERGENCY PROCEDURE

The cooking zone has turned itself off.	The maximum operating time has been reached.	Activate the cooking zone again and set the heat setting.
Noises are heard during cooking.	Normal operation of the appliance. The noises emitted depend on the pots used and the heat setting.	
The “h” or “H” symbol is shown on the cooking zone display.	Normal operation of the appliance. The “h” or “H” symbols indicate that the cooking zone is warm/hot and extra care is required.	
F0 is shown on the cooking zone display.	Supplied voltage too low.	Concerns your electricity installation. Contact Gram service
F1 is shown on the cooking zone display.	Supplied voltage too high.	Concerns your electricity installation. Contact Gram service
F2 is shown on the cooking zone display.	Electronic protection has been activated.	Check that the cooling fan opening is not obstructed.
F3 is shown on the cooking zone display.	The cooking zone protection has been activated.	Remove the cookware from the cooking zone and wait until the F3 symbol goes off.
F4 , F5, F6, F7, F8 or F9 is displayed on the cooking zone display.	External power interference.	Unplug the appliance from the power outlet for 120 seconds or disconnect the miniature circuit breaker (MCB) or fuse in your home electrical distribution box.
Cracked ceramic plate	Danger! Immediately unplug the appliance from the power supply or disconnect the miniature circuit breaker (MCB) or fuse in your home electrical distribution box. Refer the repair to the nearest service centre.	

TECHNICAL DATA

Rated voltage	220-240V/380-415 V ~50/60 Hz 2N
Rated power:	
Type:	KKI 6344-90 TI
Induction cooking zone power:	7.35 kW
- induction cooking zone:	
- induction cooking zone: Ø 160 mm	1400 W
- induction cooking zone: Ø 210 mm	2000 W
- Booster induction cooking zone: Ø 160 mm	2100 W
- Power Booster induction cooking zone: Ø 210 mm	3000 W
Dimensions [mm]:	592 x 522 x 48
Weight [kg]:	approx. 7.85

Meets the requirements of European standards EN 60335-1; EN 60335-2-6.

Power consumption in standby mode [W]	-
Power consumption in off-mode [W]	0,5
Power consumption in networked standby mode [W]	-
Automatic standby/off time [min]	1

NO:

Gram A/S

Tel.: 22 07 26 30

www.gram.no

SE:

Gram A/S

Tel.: 040 38 08 40

www.gram.se

FI:

Gram A/S

Tel.: 020 7756 350

www.gram.fi

GRAM

Gram A/S

Gejlhavegård 2B

DK-6000 Kolding

+45 73 20 10 00

www.gram.dk